

4ch Million Pixels HD Multi-functional Mobile DVR

USER MANUAL



Ver 2.0

Tips about safety instruction & direction



Please read this
Before installing
and using .

please keep this
manual for
future reference.

Before installing and using please read the following warning carefully.

- The recorder uses DC power supply, input DC range is 8V-36V, Please pay attention to VDD and GND when connecting the power, DO NOT make DVR short-circuit.
- After DVR connect camera, the initial power must be over 30W (Specific power consumption will vary depending on the external equipment),Power Supply must be provided over 30W.
- From the power supply to DVR all power cables must ensure that the diameter is thick enough to withstand more than 60Watts. For example, when the vehicle power supply output voltage is 12V , the source line must be able to withstand 5Amps or more;
- Install the equipment in the dry environment, avoid damp, drip, water spray,etc.
- To extend the life of the equipment, please install the equipment in the weak vibration part of the vehicle;
- The equipment should be installed in the vehicle interior ventilation, do not install in the closeness environment;
- Ensure that equipment away from the heat source in the vehicle, the equipment can not have sundries piled up;
- As far as possible from the electromagnetic environment, away from the strong interference environment;
- Ensure that passengers or drivers can not interfere and damage any component of the equipment.
- The installation and all materials must bear the fuselage weight.
- It is recommended that the power cord wear heat resistance, waterproof and oil proof casing which can prevent the short circuit or break up due to the long time vibration in the vehicle.;
- In the absence of professional guidance, please do not open or remove the equipment.

Introduction

The manual is about the features and specifications of one kind of car DVR, it is an integration of “4 monitoring and recording”, “Million Pixels Digital&Analog mixed car DVR”, “wireless data transmission”.

In the manual it describes the functions and considerations of the modules, the connector signal definitions in the back panel, the interface definition and user's operations. More details, please check following directory.

State:

This manual may exist any technical describe inaccurate or misprint, also the contents will be update unscheduled without notice, new contents will be added in next version;

We're subject to improve or update product description or program, if any difference, all depend on real goods, please understand.

Contents

1. System Introduction.....	5 -
1.1. Product features.....	5 -
1.2. Appearance.....	7 -
1.3 Remote Controller.....	8 -
1.4 Fron tand Back Panel.....	9 -
1.4.1 Fron LED Indicators.....	9 -
1.4.2. Back Panel IO Indicators.....	10 -
1.5 Product Introduction.....	11 -
2. Main Functions.....	12 -
3. Parameter Sheet.....	13 -
4. Real-time video interface description.....	15 -
4.1 Real-time monitoring interface:.....	15 -
4.2 Various signal status icons as follows:.....	15 -
5. Operation Interface Setup.....	16 -
5.1 User Loading.....	16 -
5.2 System Main Menu.....	17 -
5.3 Search.....	17 -
5.3.1 Video Search.....	18 -
5.3.2 Picture Search.....	19 -
5.3.3 Log Query.....	19 -
5.3.4 Dispatch.....	20 -
5.3.5 Call Records.....	20 -
5.4 System Setup.....	20 -
5.4.1Power Management.....	20 -
5.4.2 Time Set.....	21 -
5.4.3 User Management.....	22 -
5.4.4 Terminal Setup.....	22 -
5.5 REC Setup.....	23 -
5.5.1 Basic Setup.....	23 -
5.5.2 Mirror Record.....	24 -
5.5.3 Main Stream.....	24 -
5.5.4 Sub-stream.....	25 -
5.5.5 Time Record Setup.....	25 -
5.6 Network Set.....	26 -
5.6.1 Center Setup.....	26 -
5.6.2 Local Network Setup.....	27 -
5.6.3 3G/4G Setup.....	28 -
5.6.4 WIFI Setup.....	28 -

5.6.5 IPC Setup.....	- 29 -
5.6.6 FTP Setup.....	- 29 -
5.7 Alarm Setup.....	- 30 -
5.7.1 IO Alarm.....	- 30 -
5.7.2 Speed Alarm.....	- 31 -
5.7.3 Temperature Alarm.....	- 32 -
5.7.4 G-sensor.....	- 32 -
5.7.5 Voltage Alarm.....	- 33 -
5.7.6 Motion Detection.....	- 33 -
5.8 Peripheral Set.....	- 34 -
5.8.1 PTZ.....	- 34 -
5.8.2 Oil.....	- 35 -
5.8.3 Serial Port Set.....	- 35 -
5.9 Tools.....	- 35 -
5.9.1 Call.....	- 36 -
5.9.2 FORMAT.....	- 36 -
5.9.3 Parameters Management.....	- 37 -
5.9.4 Tel Set.....	- 37 -
5.10 System Info.....	- 38 -
5.11 Mainconfiguration instructions.....	- 39 -
6. Device Installation.....	- 40 -
6.1 Power Cable Connection.....	- 40 -
6.2 Audio/Video Interface Definition.....	- 41 -
6.3 Alarm In/Output Connection Mode.....	- 42 -
6.4. Disk pre-allocated technology instructions.....	- 42 -
6.5.....	- 43 -
7. FAQ.....	- 44 -
7.1 GPS related FAQ.....	- 44 -
7.2 3G Wireless Module related FAQ.....	- 45 -
7.3 Client Software FAQ.....	- 45 -
7.4 Other related questions.....	- 46 -

1. System Introduction

1.1. Product features

H.264 Compression Mode, Support 4CH real-time 720P Million Pixels AHD input and Analog Standard Definition camera input, or 2CH HD input + 2CH SD input; Exclusive pre-allocate DVR Special File System Technology, Solving repeatedly wipe cause file fragmentation, solving SD card file system collapse, data loss and cannot find SD card and file garbled, ensure the integrity of the data. 8-36V Adaptive Wide Voltage input, Super Low Power Consumption Design; HDD+SD card storage (maximum support 2TB 2.5" hard disk and 128GB SD card.) It can be completely resist car Vibration, Dust and others cause data corruption; Support GPS/BD/G-SENSOR ; High Reliability Aviation Connectors, High Cost Performance with reliable stability, simple and clear operation menu .

Features Details:

- HIS Solution, H.264 Compression Mode, Many stream recording, 4CH Video+2CH Audio Input, Compatible with **4CH 720P/960P Mega Pixels Analog High Definition Camera input. /2CH AHD High Definition + 2CH Standard Definition mixed input. / 4CH Analog Standard Definition Camera input.**
- Real-time HD Video Recording, 720P/D1/HD1/CIF for Optional, Adjustable Frame Rate Quality.
- **Professional Power Design for all kinds of Vehicles, 8-36V DC; Wide Voltage,** Over-load, Over-voltage, Short Circuit, Reverse Protection, Suitable for all kinds of vehicles.
- Support DC 12V/2.5Amp output, it can offer power for cameras, mini monitor and some peripheral device.
- **HDD + SD card Data record storage (maximum support 2TB 2.5" hard disk and 128GB SD card.)** It can be completely resist car Vibration, Dust and others cause data corruption;
- Watchdog Abnormal will trigger Restart Protection Function . It can better protect Device and Video.
- **Exclusive pre-allocate DVR Special File System Technology,** Solving repeatedly wipe cause file fragmentation, and ensure the integrity of the data.
- **By accidents power-off protection function.** Unique UPS Technology ensures the integrality of record when power failure occurs, even can for 10-15s.
- Flame out Time-lapse Video Recording Function (Highest support long delay time 24 hours.)
- Auto Recording, Time Recording, Alarming Recording Modes for Different Request.
- Display vehicle traffic status, Vehicle numbers ,Route, Super-low speed vehicle Information, Convenient management.
- Support GPS/BD, Gsensor Modules Extension.











- **3channels RS232 +2channel RS485.**
- Superior network function, can configure menu through IE, support mobile SMS to configure parameters and obtain device information.
- Support Video&Audio monitoring,2-way Intercom, PTZ control, manually Alarm,Overspeed,Geo Fence etc through remote control platform
- **8CH alarm inputs** (Doors, lights, steering, braking, reversing and all types can be configured), Can support kinds of response linkages.
- **2CH alarm output**, Support the linkage acousto-optic alarm, cut off fuel oil/power,etc .
- Support Local Auto-photo when alarm input,device pictures preview function;
- All Aviation connectors, Super stable, High Anti-shock,Easy installation Plug in and out.
- Unique WINDOWS 8 interface, Easily Smart GUI Interface, Fluent system interface is intuitive and perfect.
- **Support SD card Remote Software Upgrade/OTA remote upgrade automatically**, partition backup technology upgrade don't crash.
- Can be batch functional customization according to customer's requirements;
- Dimension and Weight Dimension : 112(W) x36(H) x138(D) mm , Weight: 360g

1.2. Appearance

Product appearance pictures are displayed as follows:



1.3 Remote Controller

Key	Function	Picture		
	Power and Standby Button,Reserved			
	To enter system settings.			
	[0—9] key:In the setting mode, 0-9 is used to select the number of menu items. In playback mode, the key 1,2,3,4 to select single channel playback, ESC Button for 4-channel playback.			
	Delete Button			
	Return to the preview picture or previous menu			
	Enter button: button for setting system parameter, selecting,,switching and playing.			
	Direction Key:up, down, left, right			
	Display system info under monitoring mode			
	Rewind button. In play mode, press REW button to select 2/4/8/16/,Press play button return to normal			
	Play Button			
	Forward button. In play mode, press this button to select 2/4/8/16/,Press play button for return normal			
	Pause button			Stop button
	Playback Page\Forward to del param\Aperture larger Key			
	Playback Page\Back del param\Aperture reduce key			
	PTZ Function key			Calling Shortcut
	Quickly setup			Snap pictures
[Others]	Reserved			

1.4 Front and Back Panel

1.4.1 Front LED Indicators

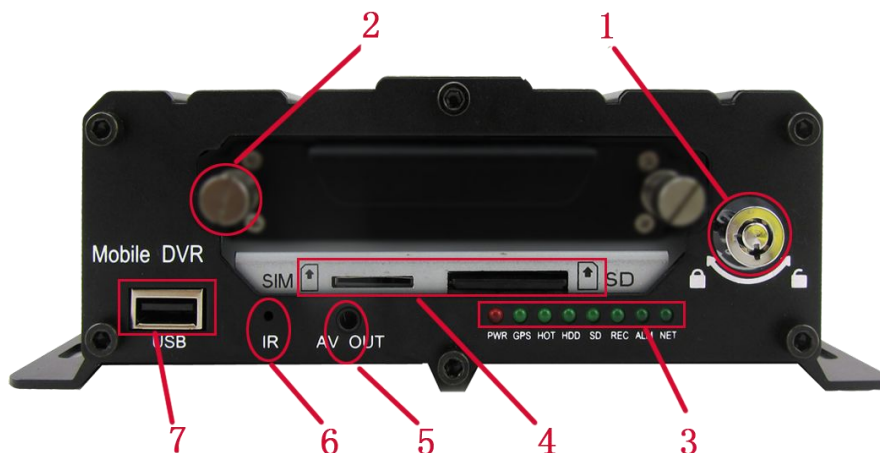

1—HDD Lock, it's used for unload hard disk.

Device will power off automatically if power on when HDD lock is open ;

2—HDD Fixed Screw . Please manually tighten screw after installing hard disk drive, to prevent HDD slip out ;

3— Status Indicator LED . Details as below :

PWR — Power Indicator LED. LED light means system has powered on.

GPS — GPS/BD Status indicator light. LED ON—Positioning success,
LED FLASH—In positioning ,LED OFF—No GPS Module.

HOT —Hard disk heating LED. LED ON—HDD is heating,LED OFF—HDD doesn't open heating.

SD — SD card Indicator LED. LED ON—Card is recording,LED FLASH—Card exists but not recording,
LED OFF—Card does not exist.

HDD — HDD card Indicator LED.LED ON—HDD is recording,LED FLASH—HDD exists but not recording,
LED OFF—HDD does not exist.

REC — Video Recording Indicator LED.LED ON—In the recording;

ALM — Alarm Indicator LED. LED ON — In the alarm ;

NET — Network Indicator LED. It changes based on dial-up connection status,details as below:

LED OFF—No communication module, LED INTERMITTENT FLASH—SIM CARD does not exist ,

LED QUICK FLASH (1:1) —Device is dialing, LED SLOW FLASH (3:1)—server connection is not OK ;

LED ON - server connection is successful.

4—SIM Card and SD Card Slot; (When installation gap towards inside, metal touch spot face down)

5—Front audio and video output interface; (Reserved)

6—Infrared remote control receiving hole,It's used to receive remote controller signal.

7—USB Interface , It's used to import or export data or upgrade;

**** Status LED will alternate loop flash when device power on, it will quick loop flash when device is upgrading ****

****** Built-in UPS, after device power off, PWR LED will be continuously on ten more seconds ******

1.4.2. Back Panel IO Indicators

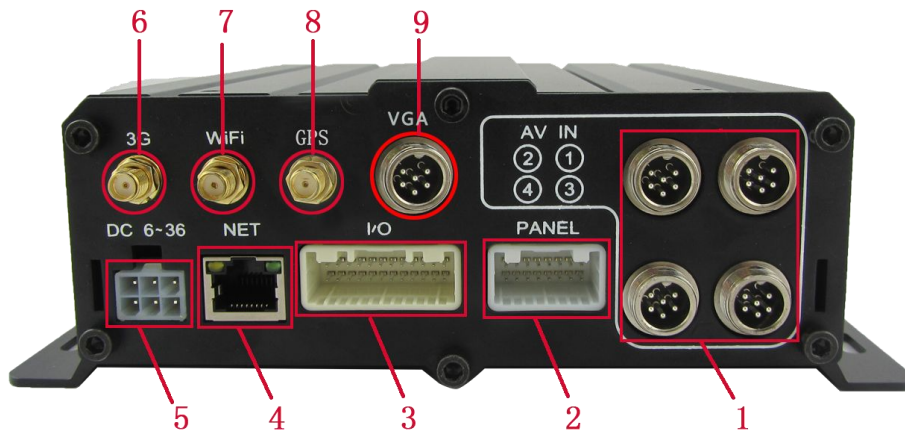

1— **Video&Audio Input interface**, 1-4Channels or 1-8Channels, with DC 12V output:

2— **16 PIN Extension Port** , With **Video&Audio output interface**、 alarm input&output、 serial port etc.

3— **24 PIN Extension Port** , With alarm input&output、 serial port etc. More detailed definition see addenda.

4— **Rj45 Ethernet port** , with print serial port, **Can only connect 4PIN net cable** when connect net cable.

5— **Power Input interface** ,Input Voltage DC 8-36V,

Red cable connect power positive,

Black cable connect power negative;

Yellow line ACC signal cable.

6,7,8— **3G、WIFI、GPS Antenna Port** ;

9— **VGA high definition output port**.(Analog output port is standard definition output);

Attention:

Audio/Video analog output port is inside the device 16PIN PANEL port

When net cable directly connect to the device, only can use **4PIN definition cable**, otherwise it will lead device dead.

1.5 Product Introduction

Before use, Please make sure that you have read this before installing and using .

➤ **Device Power Connection:**

Just only connect DVR with power supply, the power of cameras and monitors are all supplied by DVR, aviation connectors is built-in DC 12V output.

★ **Use ignition switch to control video record delay time working** ★

Red cable connect positive of the car storage battery, black cable connect negative, while yellow cable connect independent ignition switch or independent positive;

★ **switch connection** (Indoor test usually use this way) ★

Red cable and yellow cable together connect power positive of the car storage battery, while black cable connect negative;

➤ **Camera connect AV IN, monitor connect BNC connector in AV out of PANEL.**

If it's not standard aviation connector, please use the aviation conversion line mentioned in the addenda, Black side is DC 12V output, White side is Audio output, Yellow side is Video output;

➤ **Attention:**

If the camera type and DVR **setting mode(AHD HD/Analog/Mixture)** don't match, then it will show "video lost", in Mixture mode, 1,2CHANNEL is AHD high definition input, 3,4CHANNEL is analog standard definition input;

In order to get better damping effect for HDD DVR, **please horizontally install DVR** .

➤ **Tips:**

In the video preview interface, you can undertake the following actions :

- ❖ Press **F2** to enter Quick Setting, you can change the device number, server IP and port information;
- ❖ Press **LOGIN** to enter the menu, direct input password: **Administrator: 666666, User: 000000**;
- ❖ Press **INFO** to display the signal strength, dial-up connection status, hardware and software versions, storage capacity, etc.;
- ❖ Press **1.2.3.4** to enlarge the corresponding channel video, press **9** or **ESC** to return to four preview videos.
- ❖ Press the playback key  Directly start the video playback;

 **Device No. and Phone number must be the same , they are all Platform device ID**

2. Main Functions

Main	Sub-Item	Instructions
Recording Sub-System	Video Channel	4Channel video + 4Channel Audio recording synchronously;
	Resolution	Support 4*720P(1280*720),4*D1(704*576),4*HD1(704*288), 4*CIF (352*288) ; Each channel is individually adjustable.
	Image Quality	0-7 levels, 0 is the highest level.
	OSD	Overlays information such as date time and vehicle ID
	Loop Rec	Support SD card loop recording, loop cover previous video
	Record Mode	Timed recording, alarm trigger recording and manual recording
	Preview	Support 1 channel and 4 channels preview. Support enlarge video image when alarm trigger and video rear view trigger;
	Disk overwritten	Space pre-allocated Support disks overwritten function.
Playback System	Video Search	Search video files anytime per day, type(n/a)
	Playback	Support 1 to 4 channels playback.
		Support forward and backward play at the speed of: x2 ,x4,x8,x16. Support alarm spot search and time search.
GUI	Graphical User Interface	Setup system parameters with the remote control.
Alarm	Input	8 channels electrical level alarm input for optional Alarm linkage recording\Active request the intercom\One-key phone calling functions,etc.
	Output	Max support 2ch level output
Optional functions	GPS Positioning	Built-in GPS/BD module: can sync record GPS information, trace replay.
	PTZ Control	Support Pelco-D protocol 485 PTZ remote/local control,preset.
	Serial Expand	Support LED Advertisement Panel\Oil Sensor\POS\Bus Station Broadcaster\Car OBD,ect.external devices.
	G-Sensor	G-sensor,Record vehicle real-time status.
	TTS Voice Broadcast	Support TTS voice broadcast function.
	Network	Can expand WIFI module,support 801.2b/g/n, 801.2a/c Built-in EVDO/WCDMA/TD-LTE/FDD-LTE,etc, 3G/4G module.
Others	ON/OFF	System delay-time power on/off;
	File System	DVR special file recording System Technology,Exclusive car record file system,space pre-allocate,4ch single file Record,cyclic covering; To avoid the storage of the media causes file fragments, with high reliability and high stability;

***** Above parameters any changes,please refer to actual product *****

3. Parameter Sheet

Item		Parameter
OS		Linux
Language		Chinese/English/Others (can be customized)
Video Compression		H.264 Compression Mode
OSD		Overlays information such as date time and vehicle ID
GUI	Graphical User Interface	Can connect to external LED screen. Setup system parameters with the remote control.
Video Record System	Video Input	4CH 720P AHD input/4CH standard definition input/2CH high definition+2CH standard definition mixed video input ,aviation connector.
	Video Output	2CH CVBS+ VGA output for optional, 1.0Vp-p, 75Ω,Aviation,Support 1CH Full Screen,4CH Screens
	Preview	Support 1 channel and 4 channels preview.,Support Manual/Alarm Trigger full screen preview
	Resolution	720P/D1/HD1/CIF, MAX:4 channels of 720P
	Video Quality	0-7 levels, 0 is the highest level, 7 is the lowest level.
	Video Standard	PAL: 100f/s , CCIR625 line,50field; NTSC: 120f/s, CCIR525 line,60field; CIF: 256Kbps ~ 1.5Mbps, 8 level video quality optional; HD1: 600Kbps ~ 2.5Mbps, 8 level video quality optional; D1: 800Kbps ~ 3Mbps, 8 level video quality optional; 720P: 4Mbps-6Mbps, 8 levels video quality optional
	Record Mode	The default setting is auto recording after power on. Timed recording, alarm trigger recording and manual recording are supported.
Audio	Audio Input	4CH ,Aviation Plug
	Audio Output	2CH,Front port is earphone port ,rear port connects to BNC connector. The output level: 1V - 2V
	Compression	G.726 compression, 8KB/s speed
Alarm Input		8CH IO Alarm Input, 1CH AD input, pulse speed input; Support alarm linkage function
Alarm Output		2CH Relay Alarm Output, Support the linkage acousto-optic alarm, cut off fuel oil/power,etc
Communication Interface		3CH RS232, support extension device, such as POS machine, Oil Feul sensor, LED advertising screen , etc.
		2CH 485 interface, can connect PTZ,etc.
		2CH CAN interface.
Wireless transfer		Support Built-in 3G/4G network, WCDMA,CDMA2000,TDD-LTE,FDD-LTE...

		Support Built-in/External WIFI,Compatible with GPRS,EDGE
Position		Support Built GPS/BD Module,can make playback analysis of vehicle routing
G-Sensor		Support G-sensor
Video Storage	Storage	2.5" HDD+ SD Card,each max 2TB HDD + 128GB SD Card mirror recording to protect data from loss
	Upgrade	Support USB flash disk updating,SD card upgrade , OTA remote upgrade automatically
	File Format	.264 General video format
	File System	Special FAT32 File System
	USB	Front panel supports USB port, support USB flash disk upgrade to backup; hard disk box USB port, can back up video data
Video Playback	Video Search	Search video by Record Time/Record Type etc
	Playback	Max support 4CH Replay /Stop/Fast Forward/Fast Reverse at same time
		Support x 2,x4,x8,x16. fast forward or fast backward play
Safety Management		User/Admin 2 Levels Different Passwords , support screen lock
Extension Functions	TTS Voice Broadcast	Support the TTS Voice Broadcast function
	Serial Port Extension	Support kinds of Access Equipment such as LED Advertising, PTZ control, Oil Fuel Sensor,etc.
Voltage & Power Consumption	Power Management	Adaptive wide power input, support Wide Voltage, Over-load、 Over-voltage、 Short Circuit、 Reverse Protection..Support Time Setting/Delay power off
	Voltage Input	DC:+8V ~ +36V
	Voltage Output	+12V@2.5A, +5V@2.5A
	Power-off Protection	UPS Technology,All video information can be saved automatically when the power is cut off, and make sure that all the files can not be damaged.
	Power Consumption	Normal Working <5W Stand-by Status <0.5W
Working Environment	Temperature	-20℃ to +70℃
	Humidity	20% to 80%
others	Size	112(W) x36(H) x138(D) mm
	Net Weight	360g

***** Above parameters any changes,please refer to actual product *****

4. Real-time video interface description

4.1 Real-time monitoring interface:

Real-time monitoring interface status icons are displayed as follows :

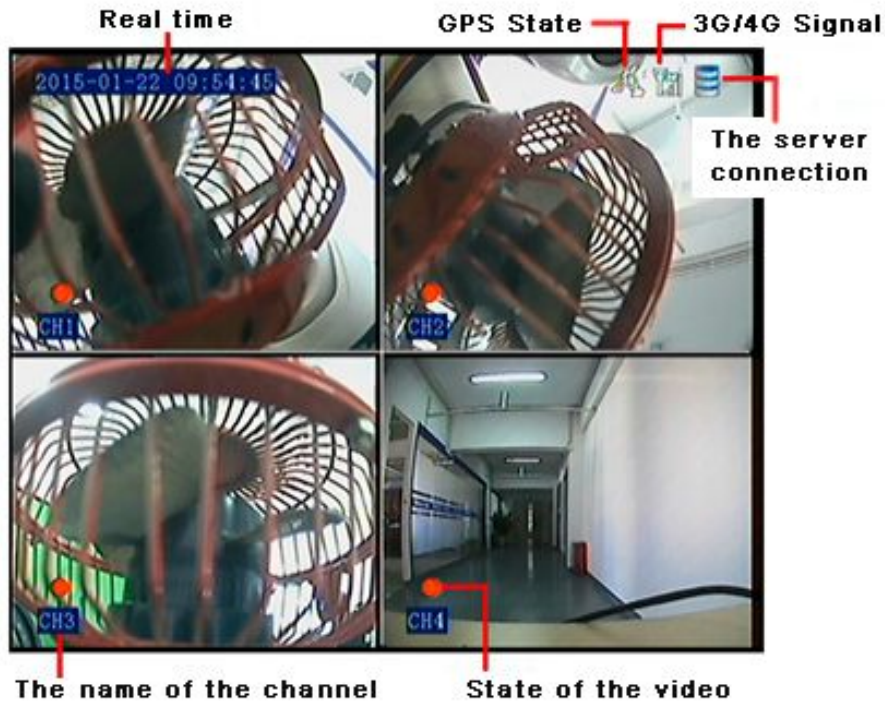

4.2 Various signal status icons as follows:

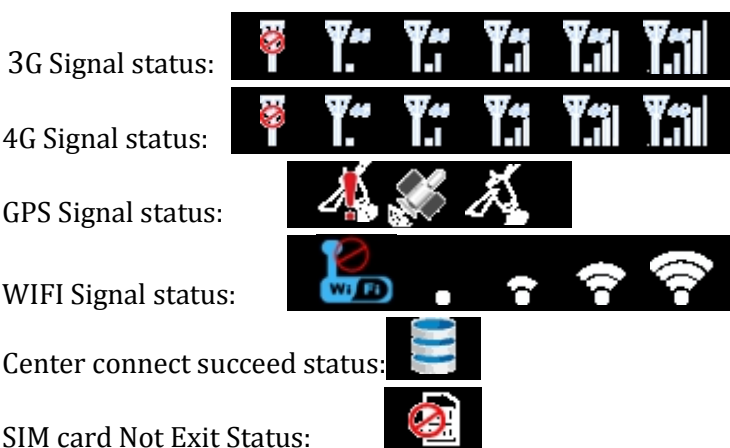

Text scheduling real-time interface displays :



Preview screen, press the remote control - on - next - right, will lock remote control, there will be an underscore prompts between the date and time;

Press the remote control - on - next - left to unlock. Video loss or reboot the device will unlock;

5. Operation Interface Setup

5.1 User Loading

- When the password switch is set to "Off": The host start and press [OK] key, will direct access to the main menu..
- When the password switch is set to "On": Move the cursor to "landing" column, Press [OK] key, then can enter the main menu.



The administrator default password is 666666 (or device number -before changed the password available); User default password is 000000, only have query permissions;

5.2 System Main Menu

The main menu includes: Search, System setup, Rec setup, Network setup, Alarm setup, Peripheral setup, System Tools, System Information, as below:



5.3 Search

Query menu includes: Record, Picture, Log, Dispatch, call records



5.3.1 Video Search



**** Green color display indicates current day and time exist video file ****

“Search Date”: Press the number key to enter date, default is current date.

“Start Time”: Press the number key to enter date, default is 00:00.

“End Time”: Press the number key to enter date, default is 23:59.

“Record Type”: Press the [OK] button to select the query type: All videos \Alarm recording. Default is All videos.

“Storage Media”: Press the [OK] button to select: all disks, disk 1, disk 2.

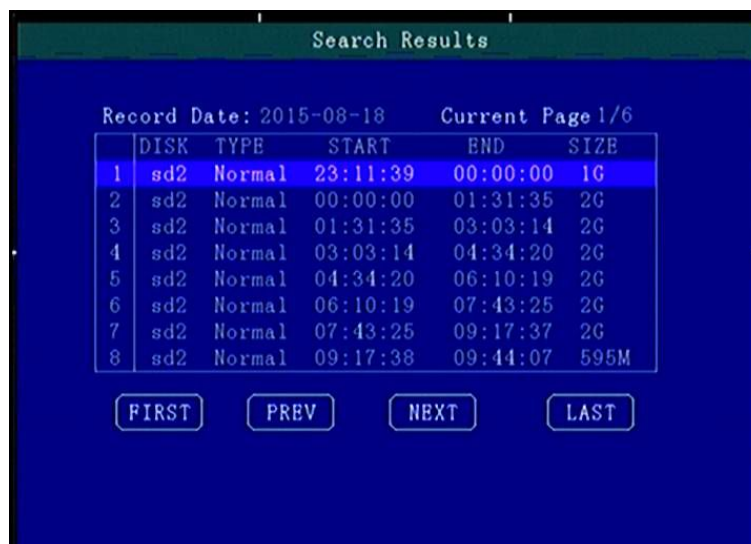

“Search”: Move the cursor to "Search" button, press the [OK] key to enter the search results interface.

Press the arrow keys to select the video you want, press the **+** **-** keys to quickly flip, press **◀** **▶** to turn to first page or last page, press the play button to play the video, press [ESC] key to return to the previous menu.

Press the arrow keys to select "Home", "Previous", "Next", "Last" and press [OK] button to display the next page information.

5.3.2 Picture Search

This menu is mainly for searching the screenshot pictures.

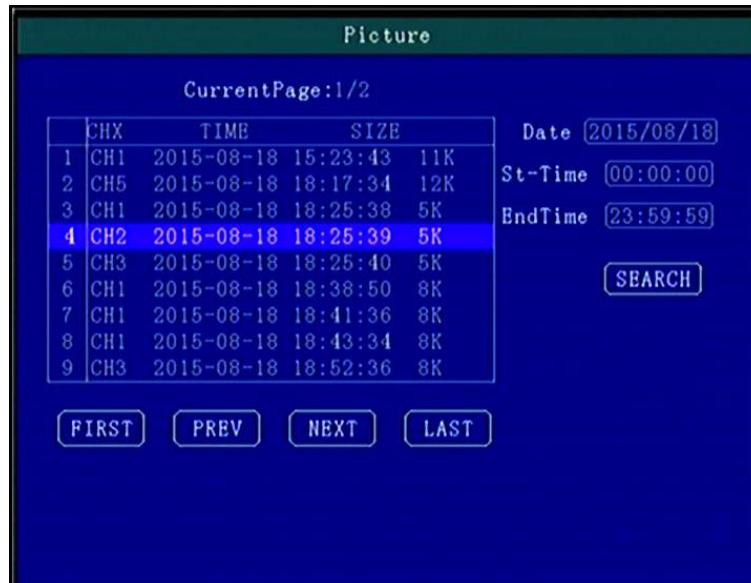

Zoom up single full screen will auto screen capture by default , it will be triggered by the alarm linkage or manually operate.

**** Pictures and device log all save in the second partition ****

5.3.3 Log Query

This menu is to query device operation and working log , you can choose the same type log via log categories.



When select a single log, press the **+** **-** keys to quickly flip over, and press **◀** **▶** to turn to first page or last page .

5.3.4 Dispatch

This menu is to query the device scheduling information, text messages, etc.

5.3.5 Call Records

This menu is to query log of device voice calls recording.

5.4 System Setup

Under System Setup menu includes: Power, time setup, user setup, terminal setup (menu setup and modifying need to choose save to take effect)

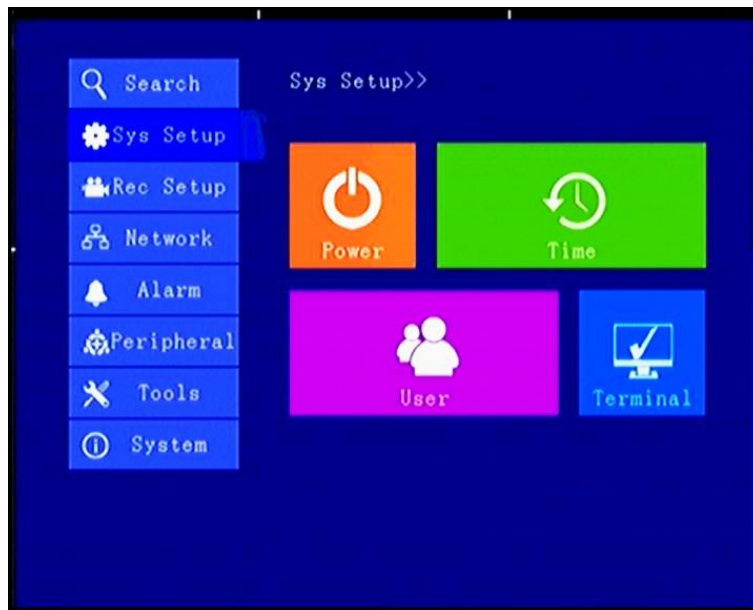

5.4.1 Power Management

This menu is to setup Power management modes and power distribution.



"Power mode": press the number keys to select the type, the default is ignition mode.

"Delay Off": Press the number keys to enter the time, the default is 5 minutes, can be set to 1440 minutes

"Screen time": Press the number keys to enter the time, the default is 60 minutes, can be set to 0-1440 minutes

"Power On": Press the number key to enter time, setup the timer start time

"Power Off": Press the number key to enter time, setup the timer off time

"Layout": optional: Single, 2-channel, 4 grids, nine grids and other video channel layout

5.4.2 Time Set

This menu is to setup device parameters, such as date and time, etc.

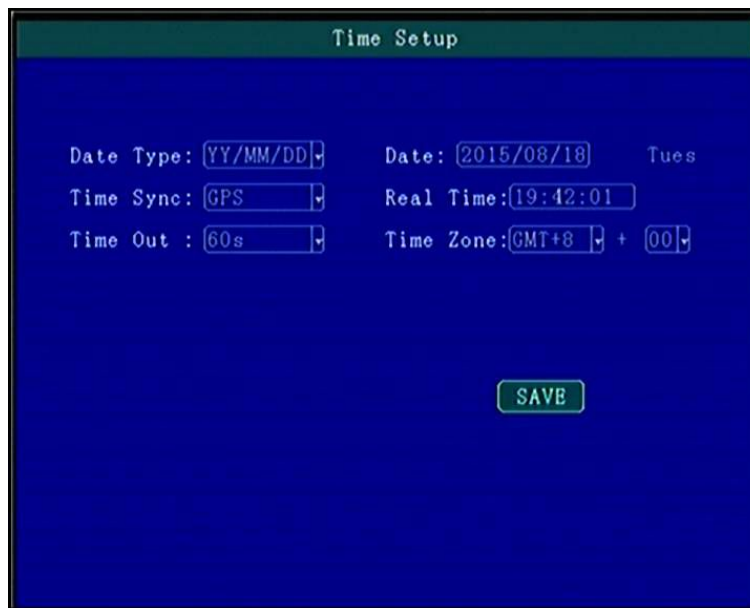

"Date Type": Different date format for choosing.

"Date": Press the number keys to enter current date.

"Time Synchronization": calibration mode: GPS, NTP and other school models available.

"Time Zone": Setup the time zone of the location of the device

"Timeout": optional remote control does not operate the exit time

"Real Time": Press the number key to enter the current time

After opening GPS time revision function, device will automatically collate the time based on corresponding time zone when device starts every time.

5.4.3 User Management

User Management

PWD-EN:

Name	Password	ConfirmPWD
USER	*****	*****
ADMIN	*****	*****

PS:Password with 6 Chars

"Password Enable": You can enable or disable password authentication to access the menu. Modify or setup password of users and the administrator by remote control.

**** ADMIN Pass : 666666, USER Pass : 000000 ****

5.4.4 Terminal Setup

Terminal Setup

Device ID: AuthNum:

Phone NO: Company :

Plate NO: ServiTEL:

CarColor: Terminal:

Car VIN: FactorID:

Car Type: TerminID:

Province:

City ID:

License :

By remote control input settings: device number, phone number, license plate number, license plate color, chassis number, vehicle type, the provincial domain ID, the City ID, driver's license number, authorization code, company name, telephone service, terminal type, manufacturer ID, terminal ID, the device management (data in accordance with the Department of standards, Chinese input can use the soft keyboard input)

5.5 REC Setup

Recording setup menu includes: basic setup, Main stream, Sub stream, mirror Recording, time recording, disk management(configuration and modification must select Save to take effect)



5.5.1 Basic Setup

This menu is to setup the basic video, audio and video parameters and can change into standard definition, AHD high definition and mixed mode.



"Video Type": PAL / NTSC, press [OK] key to select.

"Record Mode": Auto / timer / alarm recording, press [OK] key to select.

"Audio Type": G726 audio format.

"Audio Gain": 1-20 gain level to select.

"Alarm pre-recorded": pre-recorded alarm recording time of 0-60 seconds to setup, press number keys to setup.

"Alarm delay": alarm delay recording time, 120-300 seconds to set up, press number keys to setup.

"Camera Type ": Can switch the status of standard definition , high definition or mixed camera input.

Attention :

If the camera type and DVR setting mode(AHD HD/Analog/Mixture) don't match, then it will show "video lost", In Mixture mode, 1,2CHANNEL is AHD high definition input, 3,4CHANNEL is analog standard definition input;

5.5.2 Mirror Record

When there is dual storage in device, you can choose one as a mirrored video memory. And setup the recording parameters.

5.5.3 Main Stream



This manual is to setup the code stream and definition of video channel.

"Enable": open or close the channel of pre-recording function, press [OK] key to select.

"Resolution": CIF, HD1, D1 and 720P resolution for choosing, press [OK] key to select.

"FPS": 1-25 frame (P standard), 1-30 frame (N standard) channel recording frame rate for choosing.

"Image quality" setup video quality under different resolution, 4-speed adjustable.

"Audio" setup the audio recording on or off.

**** According to the storage space and quality requirements, the resolution of each channel and stream can be configured individually ****

5.5.4 Sub-stream

This menu is used to set the parameters of the transmission stream.



"Resolution" Setup the transmission resolution, press [OK] key to enter.

"FPS" Setup the transmission time frames, press [OK] key to enter.

"Image quality" setup transmission quality grade, press [OK] key to enter.

**** Sub-stream is the code stream which device upload via 3G/4G, high definition main code stream can be chose in the client-side platform ****

5.5.5 Time Record Setup

Setup the timer recording time periods, everyday can be set to two periods.

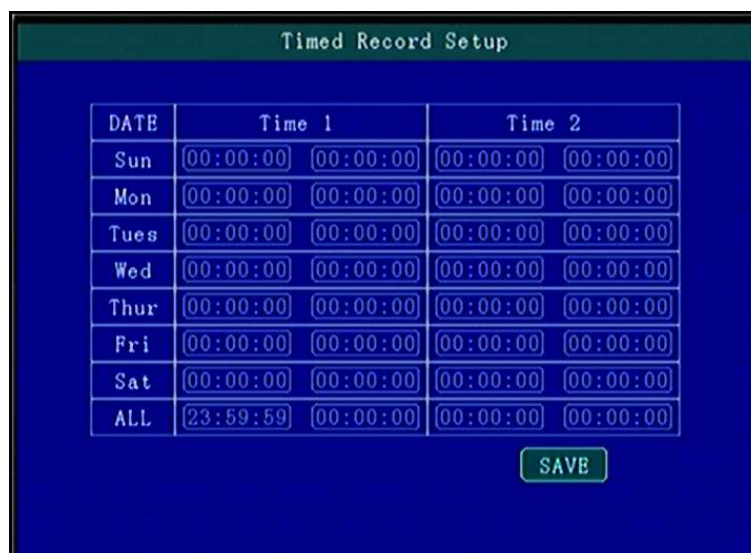

Move the cursor to "Timing Recording" and press [OK] button to set up the following timing list.

**** Timer recording start time is before the end time. ****

5.5.6 Disk Management

When there are multiple disks, they can be set up recording parameters and priority grade.



"REC": Setup main video or sub video in disk.

"Pri": Setup the priority of different memory, enabling loop recording, function missing video recording.

5.6 Network Set

Including: Center setup, Local Network, 3G setup, WIFI setup, FTP setup and IPC setup.

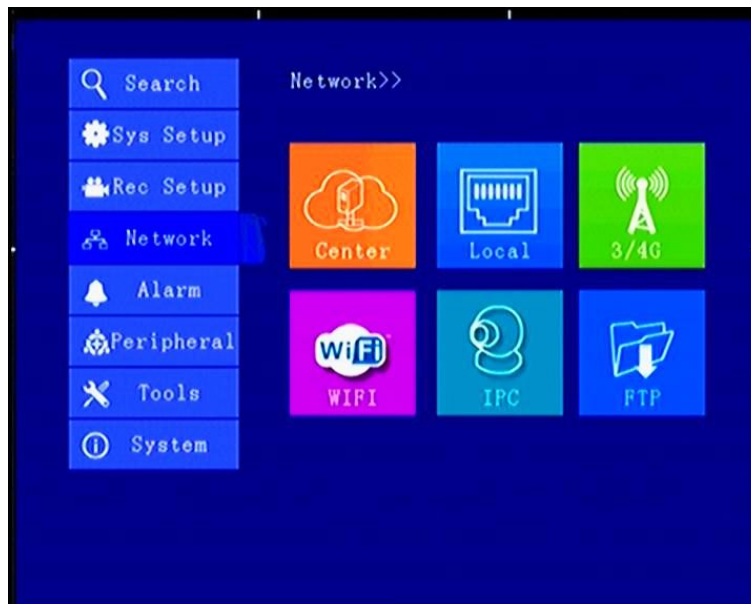

5.6.1 Center Setup

Set Server IP and Port ;

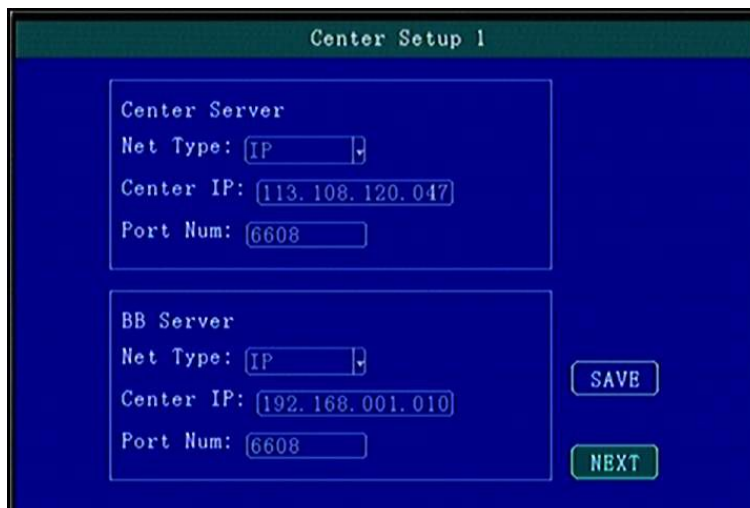

“Monitoring Center”:Set 3G /4G Video Center IP or domain,port information etc,

“Network Type”:Set 3G network type, IP address/Domain optional;

“Center IP”:3G Server IP/Domain setup. Press right key to enter keyboard interface,input the numbers via remote controller;then press [OK] for setting;

“Port”:Communication port between 3G device and Server;must be same with server configuration;

“**Group2** Center”:BD Server IP/Domain/Port Setup,make device can hang on BD server;(Chinese Government Server)

“Network Type”:BD Server network type,IP/Domain type optional;

“Center IP”:BD server IP/Domain setup,Press [OK] for setting;

“Port”:Communication Port of Device and server,port setting must be same with server configuration;

Group3 and **Group4** are kept for reserve.

In “ Info ” interface, W connected : it means device connected server already; B connected : it means device connected ministerial standard platform already, Connected : it means two platforms both connected device successfully.

5.6.2 Local Network Setup

Device Local Network setup



"IP"\ "Mask"\ "Gateway"\ "DNS1" \ "DNS2"\ "MAC":IP,Mask,Gateway,MAC setting for LAN network testing.

Attention:

When net cable directly connect to the device, **only can use 4PIN definition net cable** (please see more definition in the addenda), otherwise it will lead device dead.

5.6.3 3G/4G Setup

3G/4G Network Configuration

3/4GSetup

Enable : ON

NetType : FDDLTE

APN : etnet

CenterNo: *99#

UserName:

Password:

SAVE

"Enable":3G/4G On/Off Setting,Press [OK] for choosing;

"Type":3G/4G Type setting,WCDMA\EVDO\TD-SCDMA\TD-LTE , FDD-LTE, press [OK] for choosing,

"APN":Set 3G/4G APN,Press [OK] Input, enter into input page to set the information

"User", "Password":SIM Card Network Operation User and Password, Press [OK] for setting ;

5.6.4 WIFI Setup

WIFI Setup

WIFI-BN: OFF

Encr-BN: OFF

AU-Mode: WPA-PSK

EncType: AES

IP : 192.168.002.010

Gate: 192.168.002.001

Mask: 255.255.255.000

SSID: free-wifi

PWD : free-wifi0901

SAVE

“WIFI-EN”:WIFI On/Off Setting,Press [OK] for choosing;

“Encr-EN”: WIFI encryption ON/Off Setting,press [OK] for choosing;

“Au-Mode”: WIFI Authentication mode setting,Please choose same one with your router,

“Enc-Type”: WIFI Encryption type setting,Please choose the one same with your router,

“IP”\“Mask”\“Gateway”:WIFI IP/Mask/Gateway setting

“SSID”: Input Your WIFI SSID,

“PWD”: Same with your WIFI password,

**** According to the specific configuration of WIFI network environment, please pay attention to check the accuracy of the characters and the IP address ****

**** IP address set by WIFI and local network can not be in the same network segment ****

5.6.5 IPC Setup

This exclusive menu is reserved for 5CHANNEL DVR, Maximum configuration can support 1CH 200W IPC real time transfer data and video recording.

Enable	Protocol	Camera IP	UserName	UserPWD
ON	Type1	192.168.001.225	admin	admin888
OFF	Type1	000.000.000.000		
OFF	Type1	000.000.000.000		
OFF	Type1	000.000.000.000		

Optional: null

SAVE

5.6.6 FTP Setup

FTP Server setup for OTA Automatically grading when new firmware upgrading in FTP Server;

IP Addr: 113.108.120.047

PortNum: 21

USER :

PASSWD :

SAVE

“IP Address” “Port” “User ” “ Password”: Please do configuration of IP Add, port,user,password according FTP Server Setup.

5.7 Alarm Setup

Including: IO/Speed/Temperature/Accel/Voltage/Output

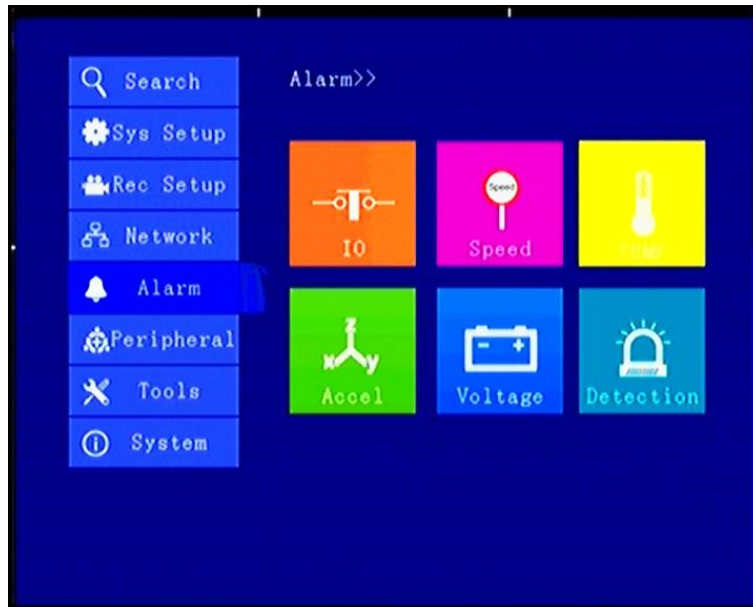

5.7.1 IO Alarm

Each channel alarm enable/level/time delay/Linkage information setting;

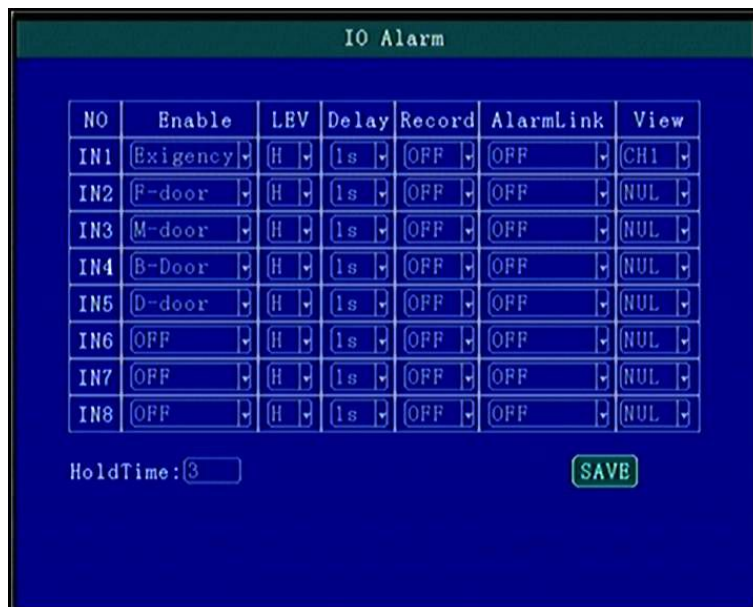

“Enable”:Alarm Trigger enable on/off and alarm type, press [OK] for changing;

“Level”:Choose Alarm trigger level,High/Low Level optional,press [OK] for optional;

“ Delay”:When alarm trigger;if need delay alarm trigger,time can be set to reduce error alarm, press [OK] for changing;

“Record”:Record set when alarm trigger, press [OK] for changing;

“Linkage”:Linkage set when alarm trigger, press[OK] for changing;

“Preview”:when alarm trigger the Channel will be full screen for preview,can realize Car Reversing,Door open alarm etc, Press [OK] for changing;

“Alarm keeping”:Set the alarm triggering time delay, which can be used to reduce misinformation.

If there isn't the specific function option you wanna display, you can choose the custom function, press “INFO” to modify the display name by custom.

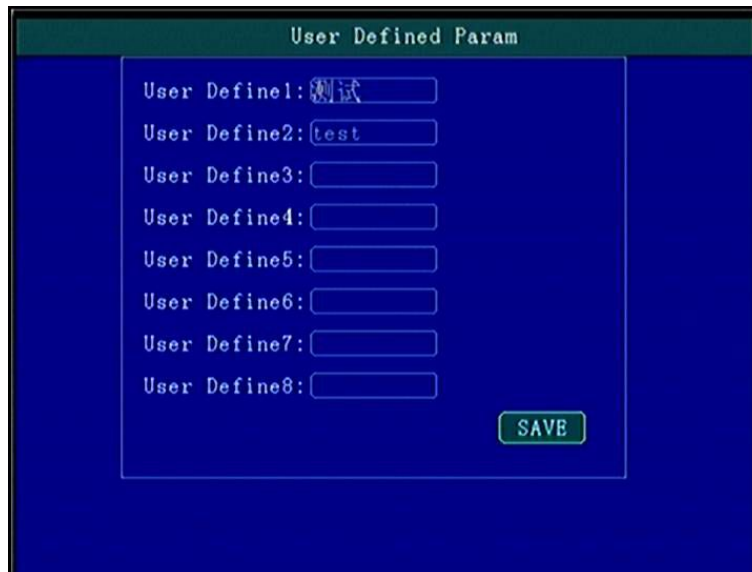

Attention:

“Enable” function cannot be repeated, otherwise it will lead to abnormal alarm report.

5.7.2 Speed Alarm

High/Low Speed or illegal driving alarm can be set.

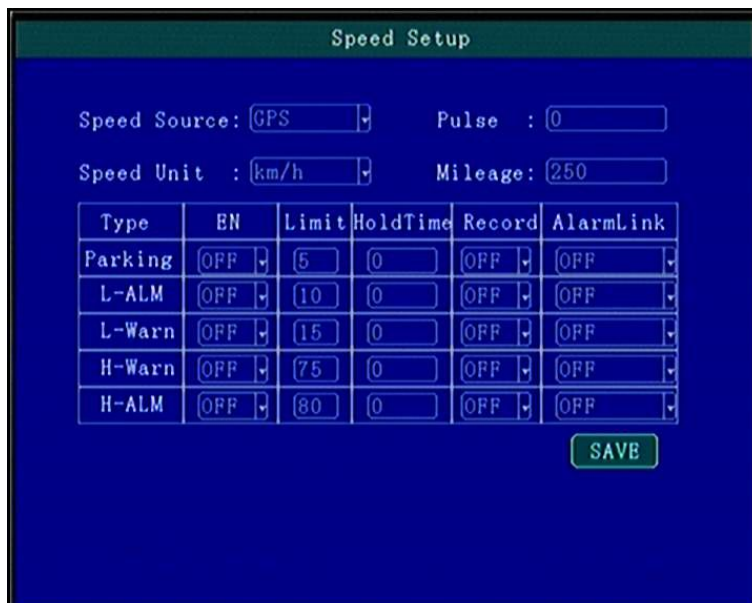

“ Speed Source”: The method to get speed, GPS/Pulse Signal Optional, Press [OK] for changing;

“ Pulse Number”:Must set Pulse factor for the standard if using Pulse to get car speed information,press Numbers for changing,can search vehicle data or constant speed by several times setting for a certain number

“ Unit”: Driving Speed Unit,Press [OK] For Changing Setting

“Timeout Parking”\“Low Speed Alarm” \“Low Speed Warning”\“High Speed Warning” :by Enable to open or close alarm function,Level setting for alarm trigger response speed and time; Delay: alarm time ;Record: if recording when alarm appear;Linkage: When alarm occurs if linkage with alarm output;

5.7.3 Temperature Alarm

Low/High Temperature Parameter Setting.



5.7.4 G-sensor

SET G-sensor information of alarm threshold and linkage actions.



Before configuration, need to calibrate the current state first, then modify the alarm threshold.

5.7.5 Voltage Alarm

Low/High Voltage alarm.

Name	BN	Limit	HoldTime	Record	AlarmLink
L-V	OFF	10	0	OFF	OFF
H-V	OFF	30	0	OFF	OFF

Limit: 8~36V

SAVE

Voltage abnormal delay shutdown: it means the voltage is kept below 8V, automatic shutdown time, this can effectively protect the battery, to avoid abnormal conditions caused by the battery voltage shortage, prolong the service life of the battery.

5.7.6 Motion Detection

This menu is to set the image changes and the parameters of the object in the video pictures.

CH-X	Enable	Limit	Action	Record	AlarmLink
CH-1	OFF	1	1	OFF	OFF
CH-2	OFF	1	1	OFF	OFF
CH-3	OFF	1	1	OFF	OFF
CH-4	OFF	1	1	OFF	OFF

SAVE

“Threshold ”: Main is area alarm percentage, generally set 1 or 2, representing 1% or 2% area change images move,it will trigger motion detection alarm.

“Sensitivity”: 0-7 levels, 0 is the highest level, 7 is the lowest level. Generally suggest to set 1, the bigger number you choose ,the lower the sensitivity will be, then it’s not easy to alarm as well.

Specific configuration parameters can depend on actual situation of the scene, such as illumination, detection area range and so on, to achieve the optimal effect.

5.8 Peripheral Set

PTZ/OIL/LED etc Serial Setting

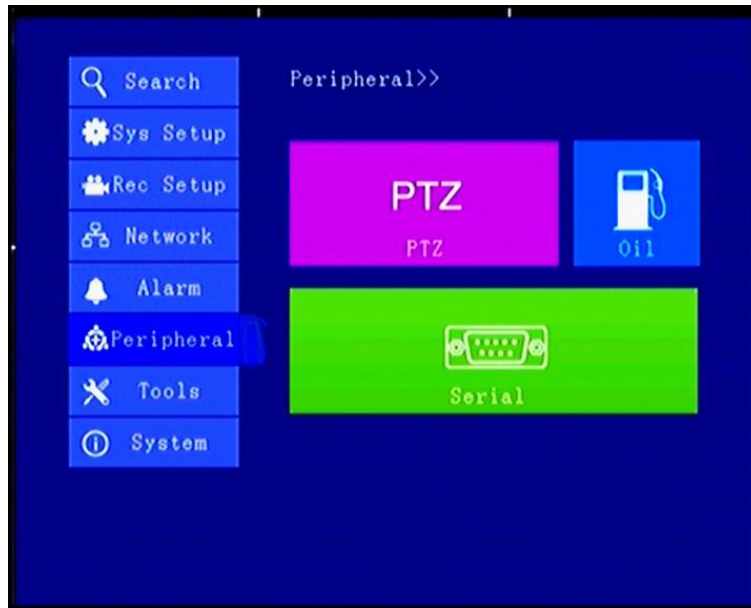

5.8.1 PTZ

PTZ Camera parameter configuration

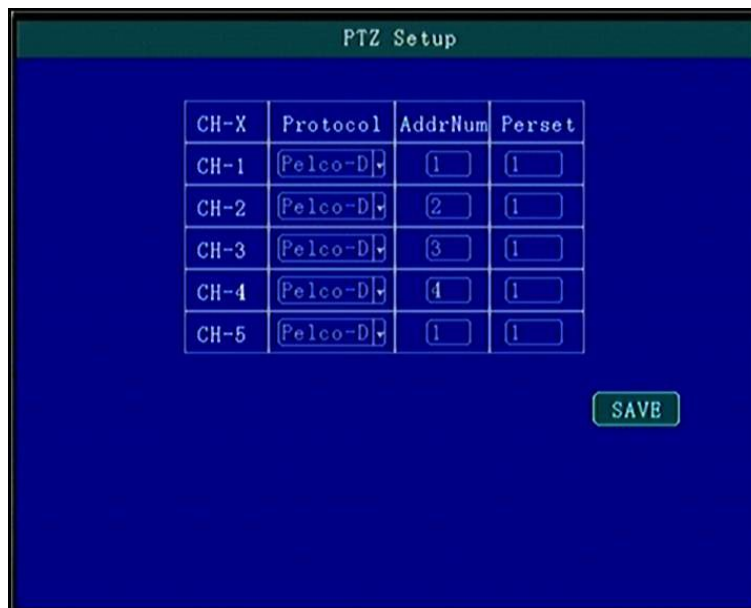

“ Protocol Type”:The Protocol of PTZ Camera support option,Press [OK] for changing;

“ ADD Code”:choose PTZ Camera Address code,press Number for changing;

“ Preset”:Choose PTZ Camera Preset code,press number for changing;

**** When using remote controller to control PTZ, after configuring parameters, need to zoom in single screen first, then press PTZ ,then use the direction keyboard to control ****

5.8.2 Oil

Reserved oil set menu, can be set on the serial port currently

5.8.3 Serial Port Set

External Device parameter setting, can connect LED Advertisement/TTS/Oil/Sensor/POS etc ;



“ Peripheral”:The external device type option,press [OK] For Changing;

“ Baud Rate”:Choose Baud Rate of external device,press [OK] for changing;

“ Data Bit”: Choose the Data bit of external device, press [OK] for changing;

“ Stop Bit”:Choose the Stop bit of external device, press [OK] for changing;

“ Check Bit”:Choose the Check bit of external device, press [OK] for changing;

“Control Bit”: Choose Control bit of external device, press [OK] for changing;

**** Just need to choose function and modify the baud rate, other options can keep default ****

5.9 Tools

Including: Phone Call,Format,Parameter/Tel Book

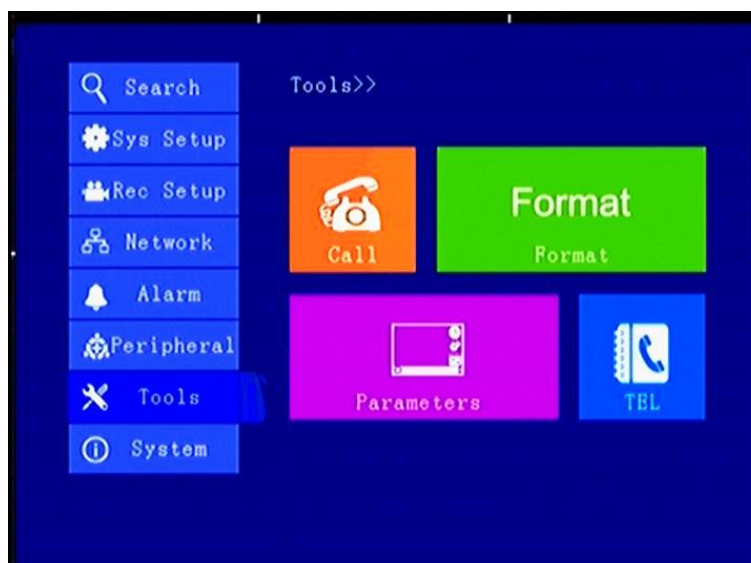

5.9.1 Call

Call Phone Number (SIM Card must support Phone Calling function) , press [OK] to enter Dialing interface



5.9.2 FORMAT

Format Disk choice, device will reboot disk after confirming, log and pictures and other related info will be reserved.



Attention:

DISK 1 is SD Card , DISK 2 is HDD.

Device will format automatically when it starts, new HDD or SD card, can be formatted on the computer, in general, it doesn't need format disk in DVR by manual.

5.9.3 Parameters Management



“Import”:Import parameters from HDD or SD Card to current device.Import the system configuration parameters which has set up and restore the factory settings to the factory states

“Export”:Export current device parameters to HDD or SD Card;

“Default”:Default to factory setting; This operation will clear all the setting on the device.

If quantity Devices with same setting,please using Parameter Export/Import for configuration, after setting one device, export these parameters to HDD or SD Card then import to other rest devices to be fast setting.

5.9.4 Tel Set

Can input detail phone number and query

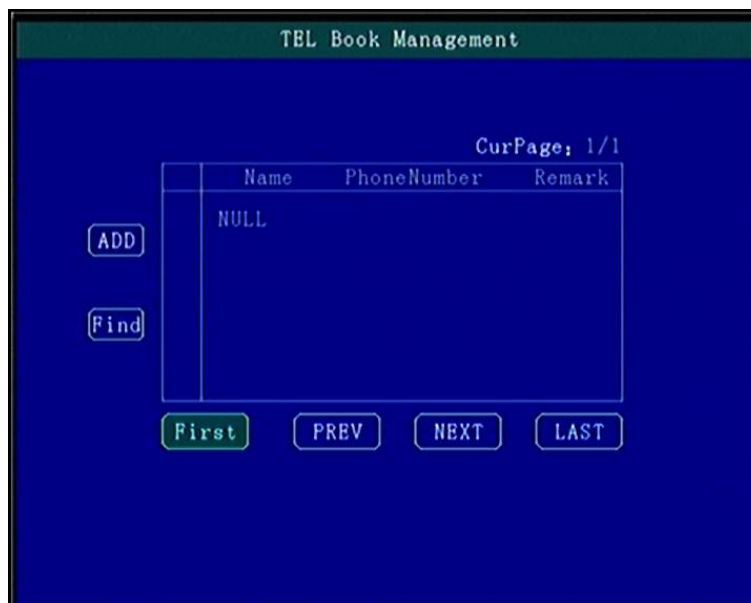

5.10 System Info

System Info have 3 parts for detail information;can view by menu or Press INFO:

System Information

```

Version: A5.03.00.w-T15081592-T15081101
GPS Position: GPS [NO WORK]
Network: 4G<DIAL SUCCESS:v22>
Speed: 0km/h           Center Link: W LINKED
Mileage: 0.3km        Call IP : 100.78.240.143
Pulse: 0/0           DeviceNo: 10000
IO : [1]0 [2]0 [3]0 [4]0 [5]0 [6]0 [7]0 [8]0
G-Sensor: X=0.12g Y=0.00g Z=-0.06g A=30.7°
Acc Status: 1 HDD Key: 1 Power: 11.8V
Center Server: 113.108.120.47:6608
    
```

NEXT

Disk and Serial

Disk Name	Total cap	Free space	Status
DISK1	118.58GB	216MB	Normal
DISK2	1861.81GB	2.44GB	Normal
DISK3	0KB	0KB	NOT EXITS
DISK4	0KB	0KB	NOT EXITS

232-1	485-1	232-2	485-2
Oil-ULT1	PTZ	OFF	OFF

NEXT

Network Information

Net Linked :3G	Module Type:FDDLTE	Net Type:UNKNOW
SIM Signal : 22	SIM Status:Exits	
Dial Status:DIAL SUCCESSal IP 100.78.240.143		

WIFI Module:No Module	WIFI SSID:
WIFI Signal: 0	WIFI IP:

Local Network: 192.168.1.181
Center Server: 113.108.120.47 :6608
Bb Server : 192.168.1.10 :6608

5.11 Mainconfiguration instructions

SIM card dial-up parameters should be set in 3/4G Setup, customers can consult APN and other related parameters from SIM card operators.



After mounting SD card, SIM card and antenna, press “info” button to check the signal strength, dial-up state, the server connection state, Next page show disk and RS232 status; Here shows positioning, the connection is successful below.

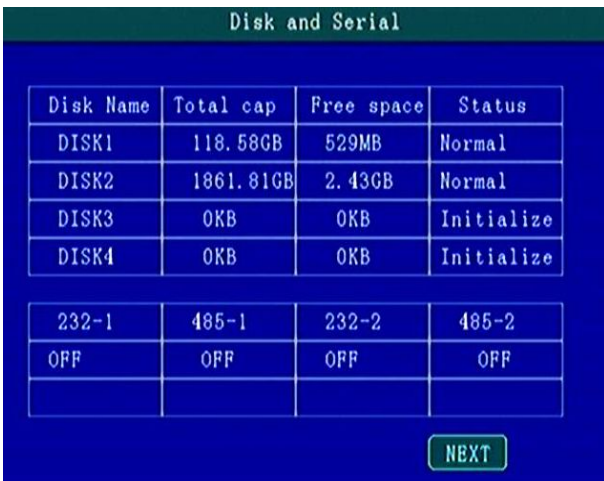
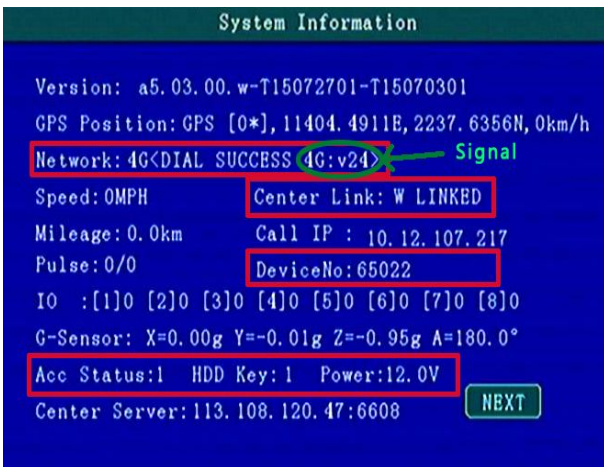

If need to change the server, press F2 to enter quick settings page, device number and mobile phone number are the same to set as the device ID, the monitoring center can change the IP for the server;

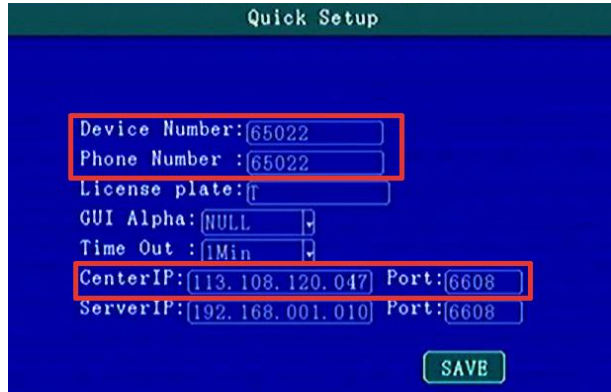

4CH DVR can switch camera input type in Video Recording Set—Basic Record Reset,choose AHD or Normal camera, after saving it will reboot automatically; In Mixture mode, 1,2CHANNEL is AHD high definition input, 3,4CHANNEL is analog standard definition input;



In video preview interface, directly press , can make video search replay.



6. Device Installation

6.1 Power Cable Connection

DVR uses DC power supply ,Working Voltage :8V - 36V.

★ **Use ignition switch to control video record delay time working**

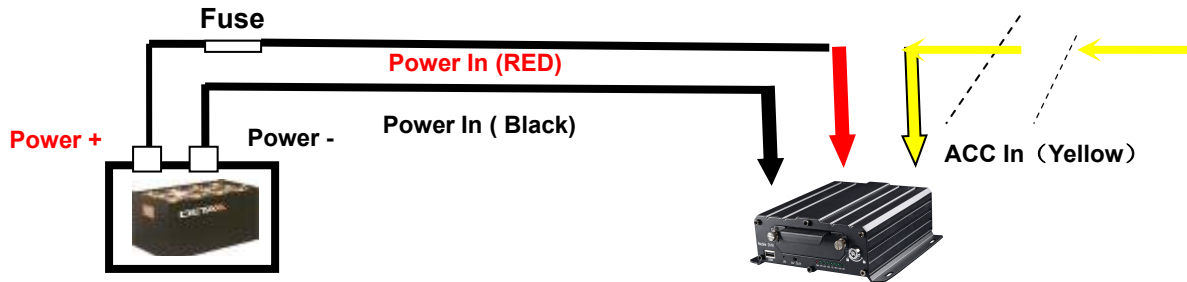

Red cable connect positive of the car battery, black cable connect negative,while yellow cable connect independent ignition switch or independent positive.

★ **ACC (Office Test also using this connection mode)**

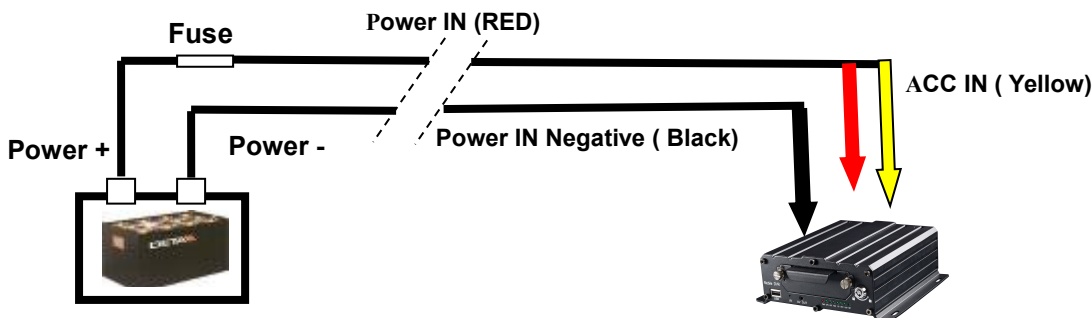

RED & Yellow Connect together with Power +,black connect with Power -

⚠ Attention

1. The recorder is DC power supply; please attention the positive and negative polar.
2. The voltage is 7V~48V.Do not insert voltage that beyond this range. Under low voltage the recorder doesn't work, under high voltage will be harm to the recorder.
3. Please make sure the recorder is connect with the car power directly. Do not connect with the generator, the instantaneous voltage will harm to the recorder.
4. The initial power will beyond 30W when the DVR connect with the Camera (the consumed power is different due to the connect with different device, the power supply must beyond 30W.
5. The power cables must can stand beyond 60W.(For example, when the output voltage of car is 12V,the power cables must can bear 5A or more.
6. Please put the cover on the cables, the cover must be wear-resistant, heat-resistant, water-proof, grease-proof, in case of short circuit and open circuit.
7. Please install a 10A fuse box near the battery output positive polar for fear of the short circuit will damage the power supply.

6.2 Audio/Video Interface Definition

 The device support channel AV1~ AV4.The aviation joint can adapt severe environment in the vehicles;

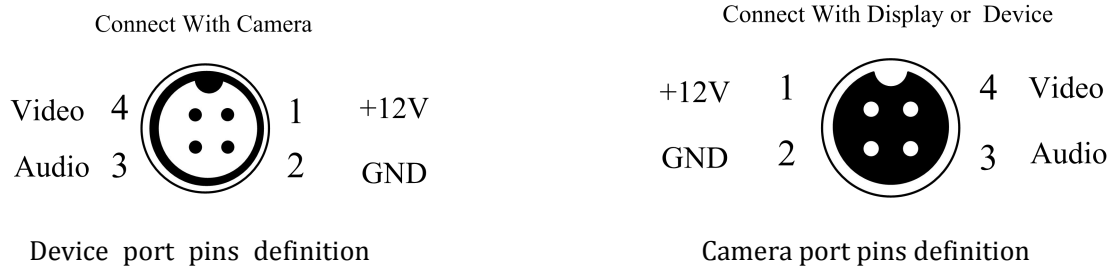

 The power in the rear panel, IO and other PIN of the interface below:

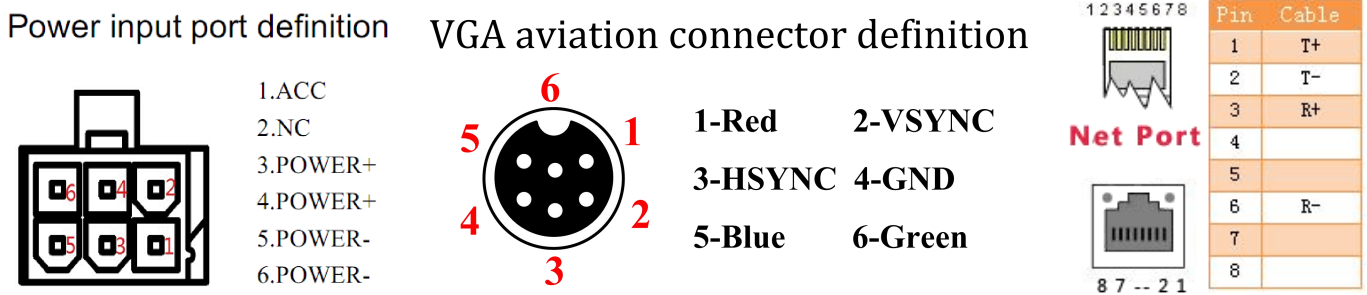

 Extension interface PIN order refers to Figure 24PIN, 24PIN and 16PIN detailed definitions are as below:

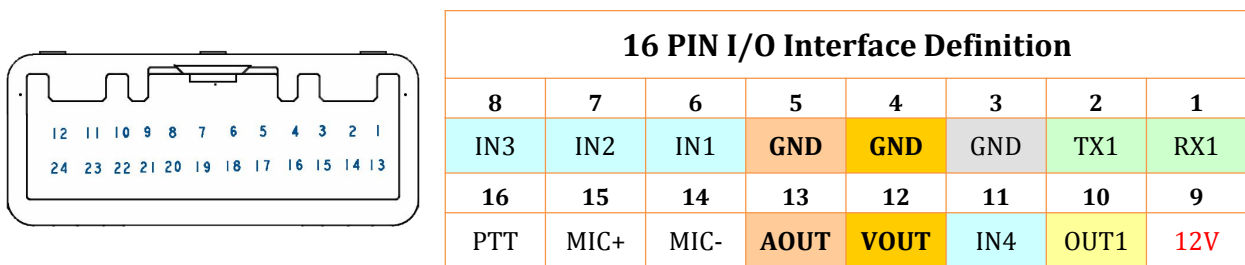

12	11	10	9	8	7	6	5	4	3	2	1
5V	GND	RX3	TX3	CAN_H1	CAN_L1	OUT2	IN9	IN8	IN7	IN6	IN5
24	23	22	21	20	19	18	17	16	15	14	13
TX2	RX2	485_B1	485_A1	485_A2	485_B2	SPEEDA	SPEEDB	GND	GND	GND	12V

6.3 Alarm In/Output Connection Mode

Device have 8CH Alarm Input Interface, 24 PIN I/O Interface Definition is IN1 - IN8 .

Alarm input usually using High Level to trigger, connect SOS button,Kinds of vehicle driving status such as: Braking,Turning,Door open etc;

The following is the brake detection diagram. When the braking vane is down, the device can detect the high level or the low level.

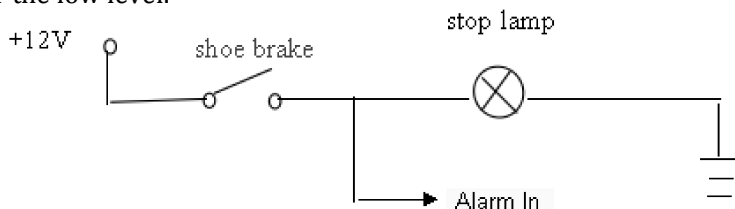

Alarm Output is Relay Switch output,can connect Acousto-Optic alarm,Remote Oil/Power cut off etc, if for high power device need connect external relay

The alarm output diagrams are as following

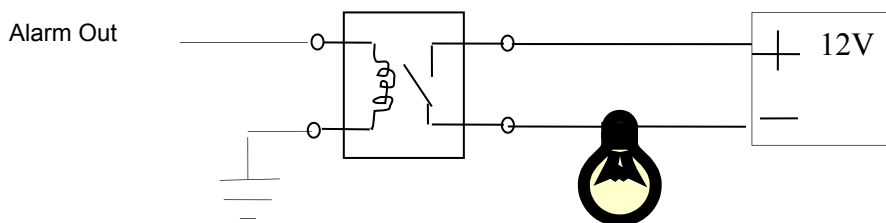

6.4. Disk pre-allocated technology instructions

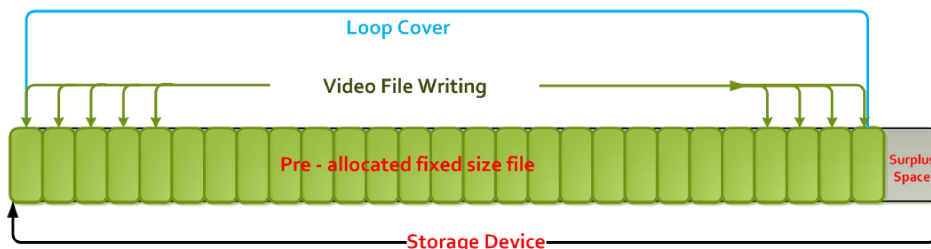

Hard Disk pre-allocated technology means, the multiple channel videos will only write in a single video file. Features: 1. it avoids repeatedly wipe cause file fragmentation; 2. Avoid long distance repeatedly reading and writing to the hard disk magnetic read; 3.Protect FAT table and catalogue area, reduce the disk failure.**Through the technology above can ensure the reliability and stability of the disk, prolong the life of the SD card / hard disk, video data security;**

Hard disk drive will be automatically created two partitions, respectively, used to store system logs and video files, including rec_dir,means video disc, multiple channels video only create into a video file.

Attention :

After new hard disk insert into DVR, when start in the first time, DVR will automatically format storage device to pre-allocate the storage space.The loading time of storage device status display normal need 2-3 minutes, the capacity of a single video file and disk is fixed;

6.5. Hard Disk box installation instructions

1. Turn over the hard disk box, dismantle 2 screws in the side and underside, as shown <Figure 1>.
2. Install 4 screws on 2.5inch hard disk, remove the hard disk box from one side bracket, as shown in <Figure 2>.
3. First connect SATA flat cable with hard disk, then insert the four braces into both sides of the bracket damping rubber ring hole, then fix two screws on the bracket, as shown <Figure 3>.
4. After installing hard disk box, fixed screws tightened hard disk, and lock the hard disk lock.



Figure 1

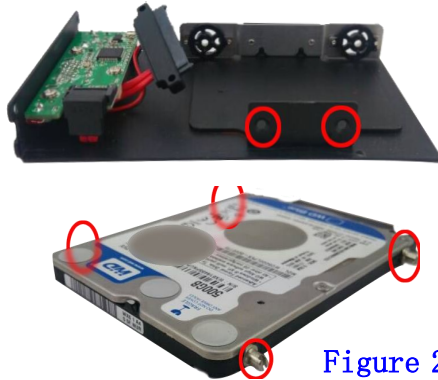

Figure 2



Figure 3

Attention :

If the storage door is unlocked, DVR **will power off automatically** in 3 minutes.

7. FAQ

Q:When Device issue appear,you are confused on how to solve it.

A:Check Device Item No & Firmware Version,sent back to us with detail description of issue.Our Technical Team will handle it.

More detail you described,easier for us to solve it quickly.

Q:Video Output Lost

A:1.Check situation of DVR:Device Input Power;Power Cable Connection;GND Connect to battery;fuse;RED & Yellow Cable of Power must connect together;

2.Check the Screen Power or Check if the Screen change to related AV Channel;

3.Check the connection of Video Output & Screen Cable;

Q:Device keep Rebooting

A:1)Check working power;if low power device will keep rebooting;

2) HDD/SD Card error, remove storage device and turn on device checking;

Q: If the video input interface of the device and camera is different.

A:The DVR is using 4 needle type port, the camera is BNC port or Aviation, if it is different, please use the X-over to connect, or connect according to the DVR Line sequence definition

Q:Device on with HDD but not recording;

A:1)Check SD/HDD if format;if not please enter Main GUI--System Set--Format,format HDD/SD Card;

2)If close Recording ,or set Timed Recording mode, if yes it won't recording if not the time set

3)If the HDD is connect well, if the HDD/SD light is on.

Q: Video files lost, or there is no video files at a certain period time.

A: 1. Analysis the lost video and ensure the lost time period.

2. Confirm if the DVR was opened at that time, such as crashed midway park, loading and unloading ect. And the device didn't set the delay recording

Q: Can not control the Car PTZ, can not rotate to all direction.

A: If the agreement and Baud rate of the PTZ is setting right,if the address code is corresponding, if the video channel is setting to max when control the PTZ. Like if is control the first channel, then must set the first channel image to be max.

7.1 GPS related FAQ

Q: With GPS but no GPS coordinate Information

A:1)Check if GPS module exist;

2)Check GPS Antenna connection,suggest install on the outside place with strong signal;

3)If testing in office, suggest put GPS Antenna out of window;

4)If working environment not good will related to no GPS Information or wrong information;

Q:Deviation of GPS Location on Map?

A:The signal is effective if the GPS module has been positioning, there are so many reasons caused bias, government restriction, permissible error, GPS signal break off, The actual satellite map error occurred for the security, GPS Correction can solve the problem.

7.2 3G Wireless Module related FAQ

Q:If using 3G ,what should we concern?

A:1)Choose inside wireless module WCDMA,EVDO,TD-SCDMA, relative module setting is different then SIM Card is different, please make sure the module is corresponding with the SIM Card.
2)If Server IP & Port set correct,if 3G signal strong for dialing;3G dialing successfully or not;
3)Check 3G Antenna connection,dialing will be failed if 3G signal too weak;
4)Check SIM Card 3G Flow

Q:When meet device offline or no video,what should be done first?

A:1)Press INFO key to enter the system Info page,check if SIM Card exist,3G signal and dialing status,Antenna connection,Check SIM Card 3G Flow,change to a new SIM Card check again;
2)3G Signal strong but dialing fail,check if center IP & Port set correct;
3)Check if Device ID already be occupied;

Q:3G Signal is intermittent, video get stuck ?

A:At present, signal coverage of the WCDMA and EVDO is very wide, but still there are some mountain area signal is weak, this will influence. Then check if the frame rate in Sub-stream setting is too high.

Q:WIFI Signal 60/100,connect failure;

A:General condition, connection is no problem when the signal intensity up to 60/100 if WIFI setup are right. If the device can not be found in LAN, then you should check if setting SSID and password, IP Address, besides, check the Encryption Type and authentication mode if setting according to requirements.

7.3 Client Software FAQ

Q:Device working but can not see Vehicle and video on client software

A: 1)Check if Center Server running and device Number if using;
2)Check Server IP and Port parameter setting;
3)Check is using 3G or WIFI for connecting, if 3G check the 3G Model WCDMA or EVDO and related SIM card,3G antenna connect normally/APN setting/Center No. setting;
If it still can not work,please offer the most detailed information to us for technical support

Q:Device Online but can not see video

A: 1) Please set Low Sub-stream, when sub-stream set high it will effect the transmission because of the network;

2) Network environment not good;

Q: Device works well in the Client, but cannot see the video a period time later.

A: 1. Check if connect to server successfully on device, if dialing probably SIM Card no 3G Flow, change another SIM card for testing;

2. Check if Device Number be changed, if yes, need add device to server again;

3. If still can not view video after previous 2 steps, please check if 3G module error;

7.4 Other related questions

Q: Video Lost in certain channel?

A: Possible reasons are as follows

1. This channel has no video input

2. The camera of this channel breaks down or work abnormality

3. If the camera takes an electricity power from the equipment directly, may be the equipment's electric voltage isn't enough to make camera work as usual;

d) The cable that links this channel has problem

Q: Can't playback files on PC successfully?

A: Possible reason is as follows:

1. Have never chosen a record file or document path; please choose the path that records file first before playback.

Q: Remote control not works?

A: Probably of the reasons are as follows:

1. The remote control didn't pack battery;

2. The remote control damages;

3. Device damages.

Q: During playback, the map doesn't show?

A: Possible reasons are as follows: Net cable did not connect to PC; Net works, but the computer can not get to the Internet;

Q: When SD card and HDD records, How is the record coverage?

A: SD card and HDD will record circularly for each other. When they are full, they will delete the original video records respectively.